

EVB2140

SSI2140 EVALUATION BOARD USER GUIDE

Support Products

EVB2140LPR1

The SSI2140 is packaged in a low-pitch 20-lead SSOP that can make prototyping a challenge. To allow easy and quick evaluation of low-pass filter functionality, we developed the EVB2140LP that brings out all of its powerful features and capability.

Two versions are available: The EVB2140LP-B blank board with only a SSI2140 attached, and the EVB2140LP-P that is fully assembled and ready for the bench. With the exception of the SSI2140, all components are through-hole for easy construction and experimentation.

Audio inputs and outputs are provided along and terminals are arranged around the board's perimeter. Frequency cut-off, resonance, unity-gain overdrive, pole switching, and three Q-compensation schemes are selectable. The on-chip tempco or an external resistor can be optionally be activated, and an onboard reference allows precise Q and Frequency control.

The schematic, bill of materials, and a user guide follow; refer to the SSI2140 data sheet for detailed information on use of the IC.

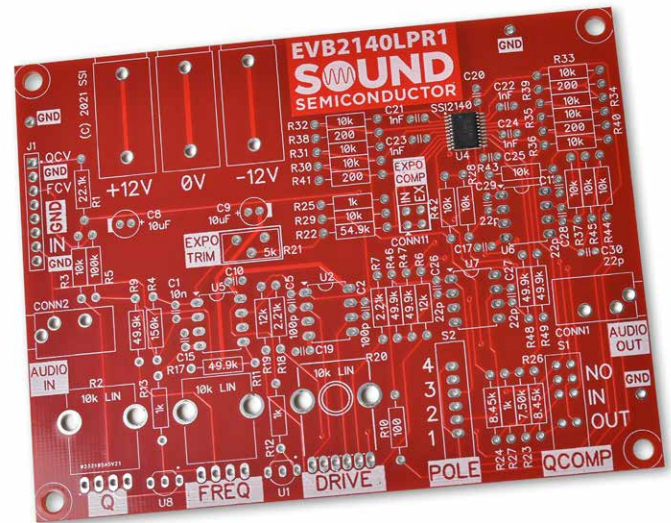

EVB2140LPR1-B

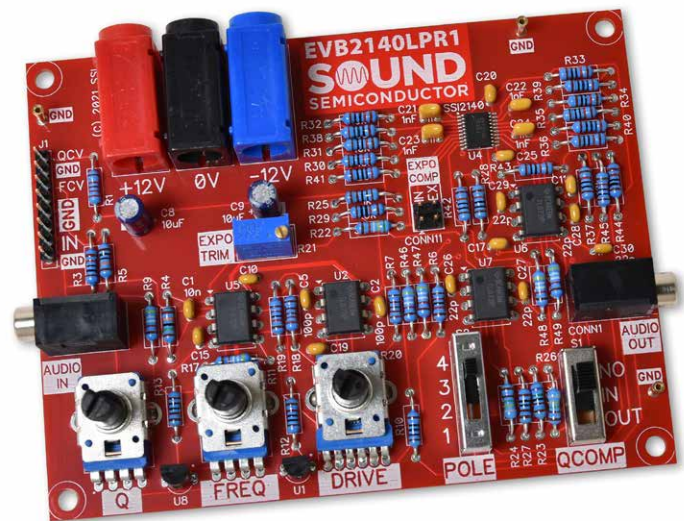

EVB2140LPR1-P

SPECIFICATIONS

- PCB size: 108 x 82mm
- External Power: $\pm 12V$
- Inputs:
 - Frequency CV
 - Q CV
 - Audio In - Jack
 - Audio In - Terminal
- Outputs:
 - Audio Out - Jack
 - Audio Out - Terminal
- Controls:
 - Resonance (Q)
 - Frequency Cutoff
 - Unity-Gain Overdrive
 - 1 - 4 Pole Operation
 - Q Compensation
 - Tempco In/Out

The EVB2140 is available exclusively from Sound Semiconductor and its authorized resellers

PO Box 1587, Arroyo Grande, CA 93421 USA, www.soundsemiconductor.com

Sound Semiconductor, Fatkeys, and ProCircuit are trademarks of Sound Semiconductor. Mask Works protected by the Semiconductor Chip Protection Act.

Rev. 1.1 July 2022

Copyright © Sound Semiconductor, Inc. 2022

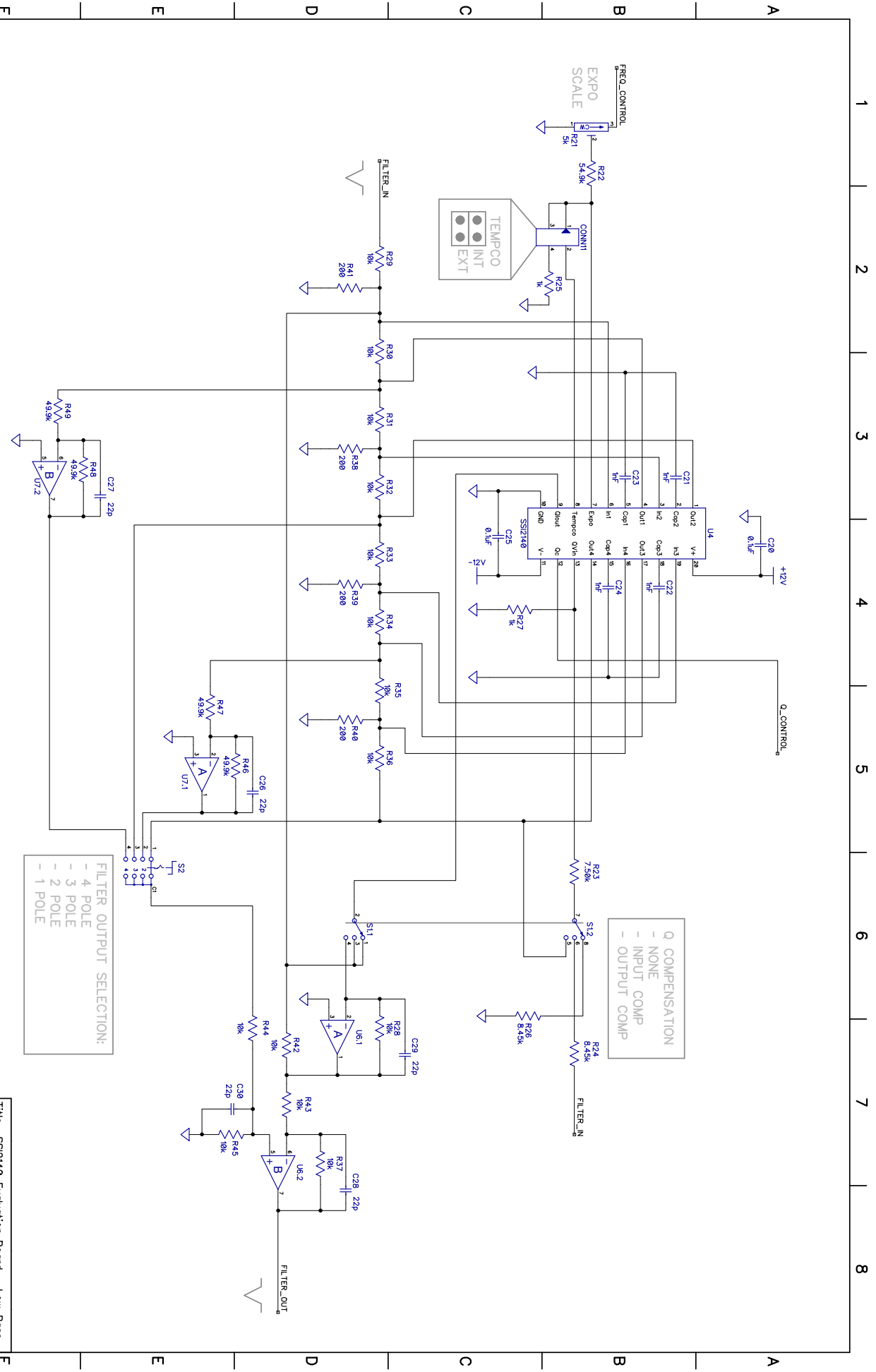

FILTER OUTPUT SELECTION:
 - 4 POLE
 - 3 POLE
 - 2 POLE
 - 1 POLE

Q COMPENSATION
 - NONE
 - INPUT COMP
 - OUTPUT COMP

Title		SS12140 Evaluation Board - Low Pass	
Size	Number	Rev	
	EVB2140LPR1	1	
Date	2022-01-03		Drawn by NU
Filename	Sheet		

1 2 3 4 5 6 7 8

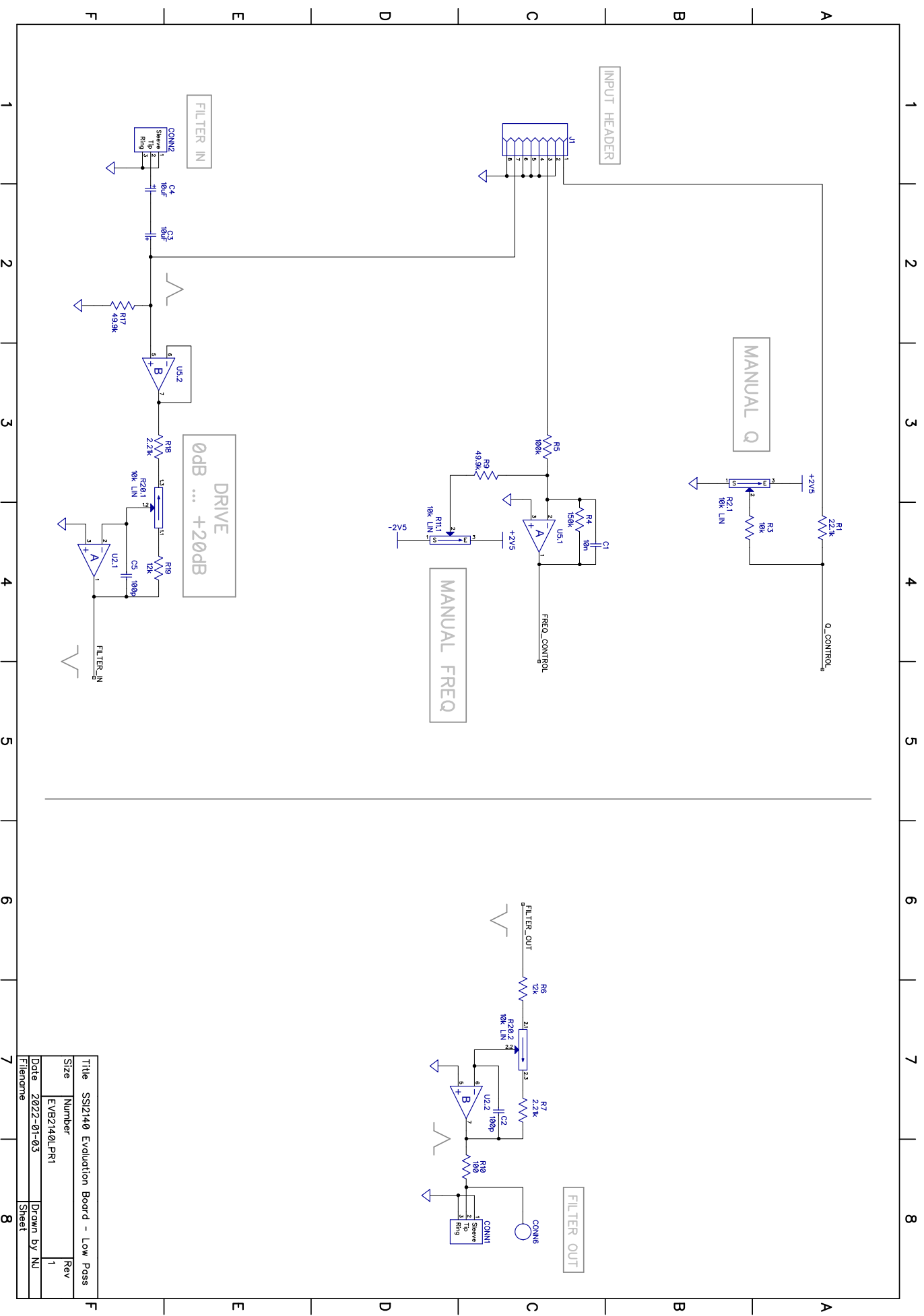

Title		SS12140 Evaluation Board - Low Pass	
Size	Number	Rev	
	EVB2140LPR1	1	
Date	2022-07-03		Drawn by NU
Filename	Sheet		

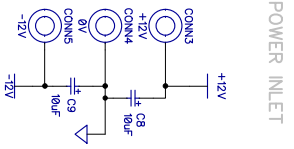

POWER INLET

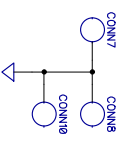

GROUND POINTS

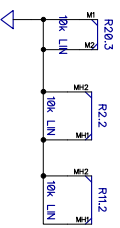

POT MOUNTING POINTS

VOLTAGE REFERENCES

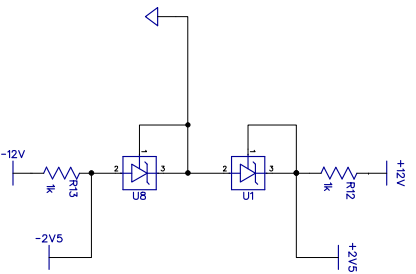

OPAMP SUPPLIES

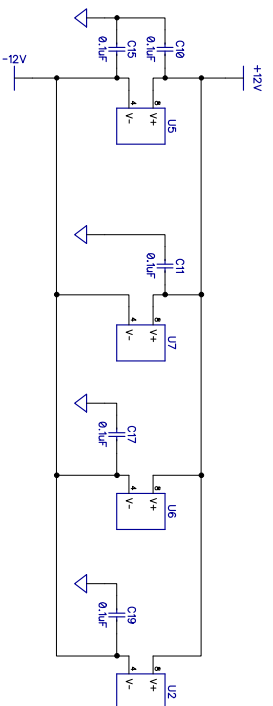

Title		SS12140 Evaluation Board - Low Pass	
Size	Number	Rev	
	EVB2140LPR1	1	
Date	2022-01-03		Drawn By NU
Filename			Sheet

BILL OF MATERIALS

Type	Reference	Value	Digikey P/N	Note
Resistors	R1	22.1k	22.1KXBK-ND	
	R2	10k	118-PTV111-4420A-B103-ND	Bourns Linear Pot - Q
	R3	10k	10.0KXBK-ND	
	R4	150k	150KXBK-ND	
	R5	100k	100KXBK-ND	
	R6	12k	MFR-25FBF52-12K-ND	
	R7	2.21k	2.21KXBK-ND	
	R9	49.9k	49.9KXBK-ND	
	R10	100	100XBK-ND	
	R11	10k	118-PTV111-4420A-B103-ND	Bourns Linear Pot - FREQ
	R12	1k	1.00KXBK-ND	
	R13	1k	1.00KXBK-ND	
	R17	49.9k	49.9KXBK-ND	
	R18	2.21k	2.21KXBK-ND	
	R19	12k	MFR-25FBF52-12K-ND	
	R20	10k	PTV112-4420A-B103-ND	Bourns Linear Pot - DRIVE
	R21	5k	490-2926-ND	Bourns PV36 Trim Pot - EXPO
	R22	54.9k	54.9KXBK-ND	
	R23	7.50k	7.50KXBK-ND	
	R24	8.45k	8.45KXBK-ND	
	R25	1k	1.00KXBK-ND	
	R26	8.45k	8.45KXBK-ND	
	R27	1k	1.00KXBK-ND	
	R28	10k	10.0KXBK-ND	
	R29	10k	10.0KXBK-ND	
	R30	10k	10.0KXBK-ND	
	R31	10k	10.0KXBK-ND	
	R32	10k	10.0KXBK-ND	
	R33	10k	10.0KXBK-ND	
	R34	10k	10.0KXBK-ND	
	R35	10k	10.0KXBK-ND	
	R36	10k	10.0KXBK-ND	
	R37	10k	10.0KXBK-ND	
	R38	200	200XBK-ND	
	R39	200	200XBK-ND	
	R40	200	200XBK-ND	
	R41	200	200XBK-ND	
	R42	10k	10.0KXBK-ND	
	R43	10k	10.0KXBK-ND	
	R44	10k	10.0KXBK-ND	
	R45	10k	10.0KXBK-ND	
	R46	49.9k	49.9KXBK-ND	
	R47	49.9k	49.9KXBK-ND	
	R48	49.9k	49.9KXBK-ND	
	R49	49.9k	49.9KXBK-ND	

Type	Reference	Value	Digikey P/N	Note	
Capacitors	C1	10nF	BC5134-ND		
	C2	100pF	BC5129-ND		
	C3	10µF	399-6598-ND	Polarized	
	C4	10µF	399-6598-ND	Polarized	
	C5	100pF	BC5129-ND		
	C8	10µF	399-6598-ND	Polarized	
	C9	10µF	399-6598-ND	Polarized	
	C10	0.1µF	BC3324-ND		
	C11	0.1µF	BC3324-ND		
	C15	0.1µF	BC3324-ND		
	C17	0.1µF	BC3324-ND		
	C19	0.1µF	BC3324-ND		
	C20	0.1µF	BC3324-ND		
	C21	1nF	478-4854-ND		
	C22	1nF	478-4854-ND		
	C23	1nF	478-4854-ND		
	C24	1nF	478-4854-ND		
	C25	0.1µF	BC3324-ND		
	C26	22pF	399-13930-1-ND		
	C27	22pF	399-13930-1-ND		
	C28	22pF	399-13930-1-ND		
	C29	22pF	399-13930-1-ND		
	C30	22pF	399-13930-1-ND		
	Switches	S1		CKN10396-ND	C&K SS23E06G5
		S2		679-2621-ND	SLB1470
	Connectors	CONN1		CP1-3533N-ND	1/8" Audio Jack
		CONN2		CP1-3533N-ND	1/8" Audio Jack
		CONN3	+12V		Newark – Multicomp 80P3614 (red)
		CONN4	0V		Newark – Multicomp 80P3613 (black)
		CONN5	-12V		Newark – Multicomp 80P3616 (blue)
CONN6 – 10			ED90074-ND	Mill-Max GND Pin Receptacles	
CONN11			609-3209-ND	Bergstik 2 x 2 Pin Header	
n/a			S9337-ND	Shunt for CONN 11 2 x 1 Header	
	J1		609-3257-ND	Sullins 1 x 8 SIL Header	
IC's	U1		TL431ACLPRAGOSCT-ND	TL-92-3 Bent-Lead Reference	
	U2		296-14997-5-ND	TL072IP	
	U4		SSI2140		
	U5		296-14997-5-ND	TL072IP	
	U6		296-14997-5-ND	TL072IP	
	U7		296-14997-5-ND	TL072IP	
	U8		TL431ACLPRAGOSCT-ND	TL-92-3 Bent-Lead Reference	
	Misc.	PCB2140LPR1			PCB for EVB2140LPR1
Knobs			1722-1238-ND		
Standoffs				1" Nylon, Threaded (optional)	
Screws				6/32" - 40 (4) (optional)	

USER NOTES

INTRODUCTION

Welcome to the SSI2140 Low-Pass (LP) Evaluation Board User Guide! This short document will get you started to harness the awesome capabilities of the SSI2140 Voltage-Controlled Filter in a variety of low-pass configurations.

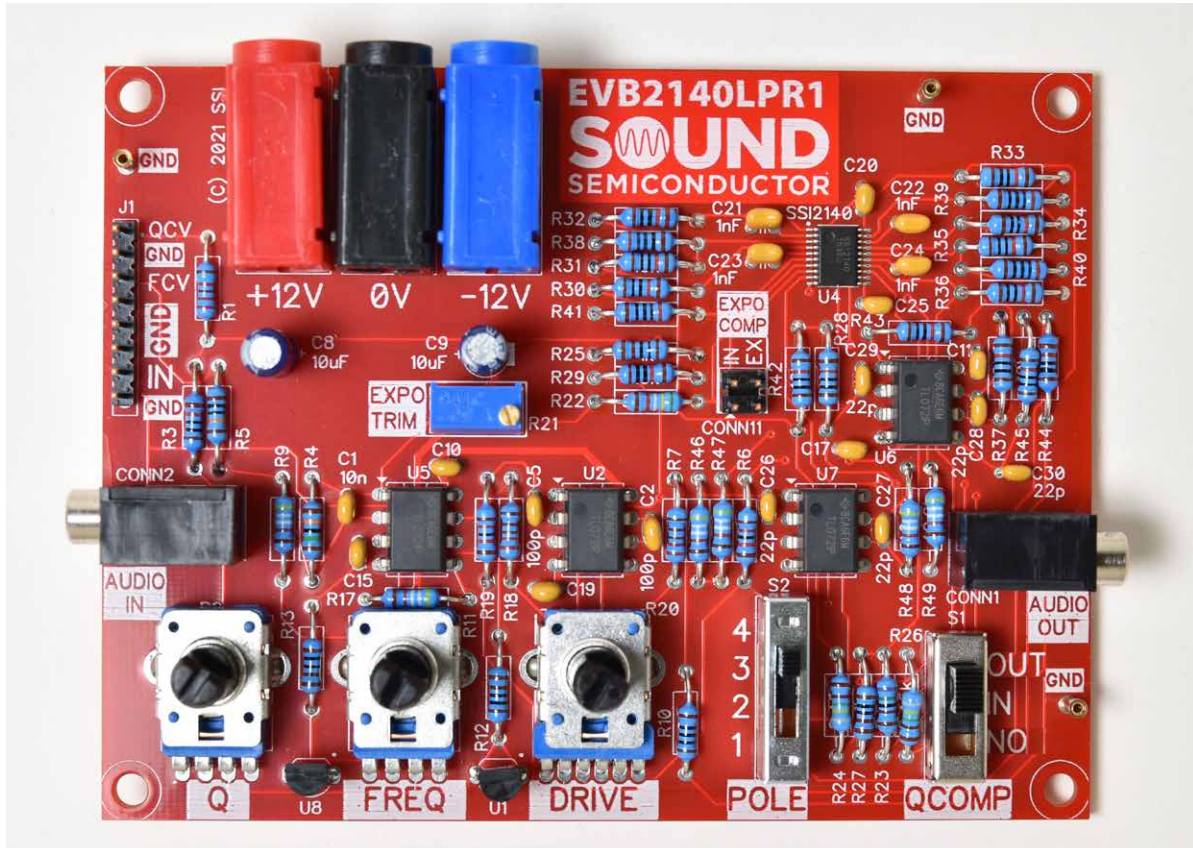

SETTING UP

Power Supplies

The EVB2140LP needs very little additional support to get it going. With an onboard reference, the only power needed is a dual (bipolar) $\pm 12V$ bench power supply. +12V goes into the red (left) banana socket, GND/COM/0V goes to the black (middle) socket, and -12V goes to the blue (right) socket.

Signal Connections

All connections to the EVB2140LP are brought out to the sides of the board. Ground terminals are positioned around the board as well as with-in headers for convenience. Almost all of the signal connections to the EVB2140LP are suitable for oscilloscope probes or small clips. In addition the audio input and output are brought out to 3.5mm mono jack sockets for easy connection to audio equipment.

Initial Jumper "Shunt" Setup (see photo above)

EXPO COMP: Fitted as "IN"; connects internal temperature compensation resistor in the SSI2140 giving optimum compensation.

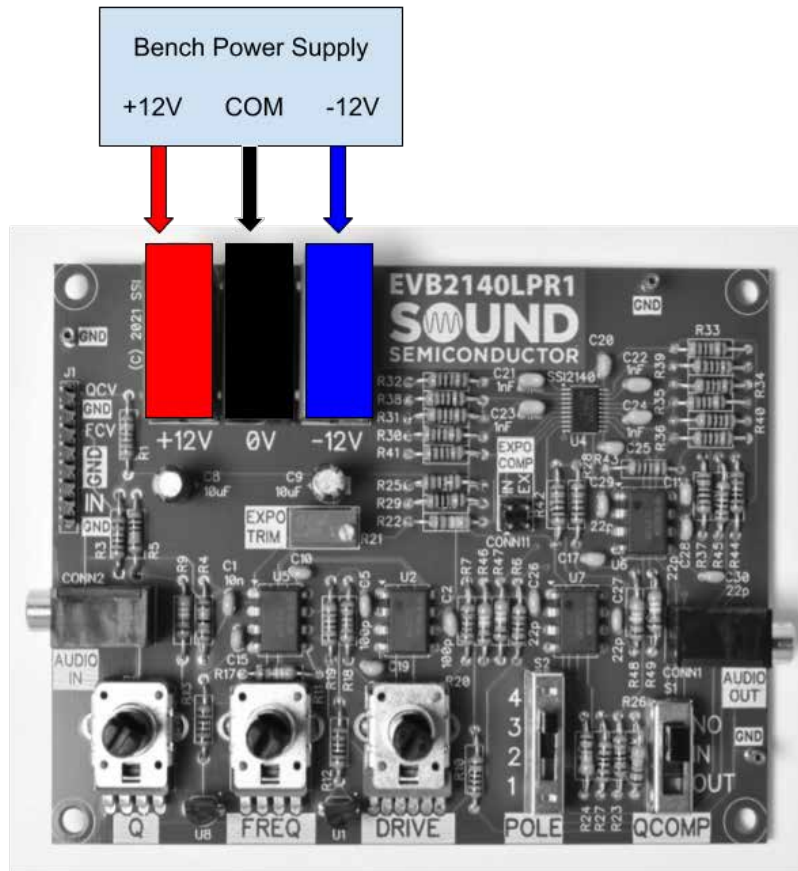

AUDIO INPUT, OUTPUT, AND OVERDRIVE

There are two audio inputs. The 3.5mm input jack is AC-coupled to the input, blocking any DC offsets. The Audio Input pin on the header is a direct DC-coupled input allowing the designer to explore the effects of DC bias on the filter behavior.

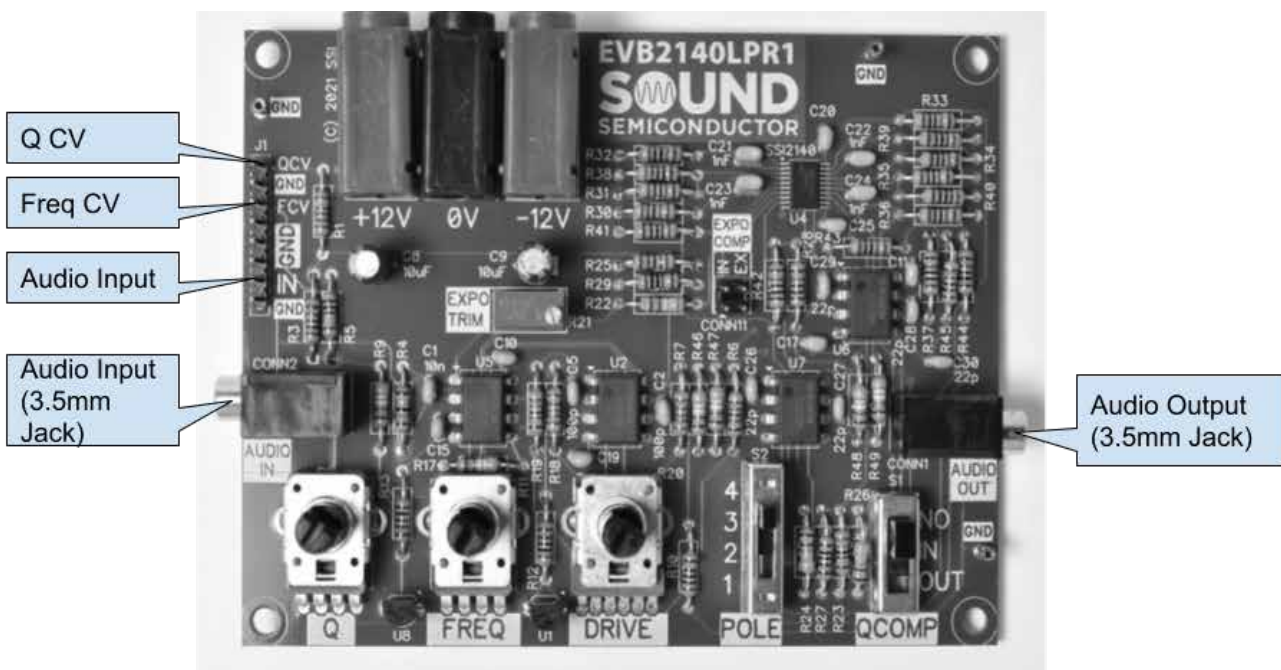

The Audio Output is available on both a 3.5mm mono jack socket and on a terminal pin.

The DRIVE pot controls the amount of overdrive. In the leftmost (CCW) position there is no overdrive and the input is fed directly into the filter. As the DRIVE pot is turned clockwise an increasing gain is applied to the input, and a corresponding attenuation applied to the output to keep the signal level constant. At full turn a gain of +20 dB is applied to the input, and the output is reduced by -20 dB.

FREQUENCY CONTROL

The FREQ pot, together with the FCV pin, produce a control voltage to set the cut-off frequency of the SSI2140. The range of the FREQ pot is about 10 octaves.

The two-way header EXPO COMP sets the temperature compensation of the cutoff frequency control. In the "IN" position the internal TEMPCO resistor in the SSI2140 is connected. In the "EX" position an external 1k Ω resistor is used instead, disabling compensation.

The EXPO TRIM adjusts the scale of the frequency controls allowing the user to experiment with different scales, for example 1V/octave or 1.2V/octave. Maximum sensitivity on this board is approximately 700mV/octave, which can be increased by reducing the value of R22 from the recommended 54.9k.

RESONANCE CONTROL

The Q pot and the QCV pin together control the current into the QVCA control pin. With the pot turned to the left Q is minimal, while at the far right Q is maximum and will cause the SSI2140 to self-oscillate.

FILTER MODE AND COMPENSATION

The POLE switch selects which of the four pole taps to send to the out. Each pole adds a -6dB slope to the filter response, giving a control range of 6, 12, 18 and 24dB/octave.

The QCOMP switch similarly selects the Q compensation scheme. In the "NO" position there is no Q compensation, and so the passband is attenuated as the Q is increased. The "IN" position selects input compensation, while the "OUT" selects output compensation. Please refer to the SSI2140 datasheet on the details of these two compensation schemes.